



FLUXJET

1.1kW 1.5kW (50Hz); 1.5kW (60Hz) SINGLE PHASE
1.1kW 1.5kW 2.2kW (50Hz); 1.3kW 1.75kW 2.55kW (60Hz) THREE-PHASE

Per l'aspirazione di fluidi diversi dall'aria non contaminata o a temperature superiori ai 40°C vi preghiamo di contattarci.

The standard side channel blowers/aspirators are designed to handle clean air up to a maximum of 40°C. Please contact us for special applications.

Motori costruiti secondo le norme CEI 2-3 (1988) ISOL. CL F PROT. IP 55 e certificati cCSAus (monofase cCSAus su richiesta)

Motors construction conform with CEI 2-3 (1988) NORMS. ISOL. CL F PROT. IP 55, cCSAus certified (single-phase cCSAus upon request)

cCSAus file nr. 242079

	Articolo	kW	V	Hz	assorb. AMP	giri/min.	limite servizio		sonda termica	dB (A)*	peso (Kg)
	Item code				absorbed AMPS		r.p.m.	max cont. duty	µF/V		
MONOFASE SINGLE-PHASE	048137	1.1	230	50	7.6	2850	-145 +145	40 / 450	bimetal (klixon)	68	21
	048139	1.5	230	50	10	2850	-185 +185	40 / 450	bimetal (klixon)	68	21
	048116	1.5	220	60	12	3450	-180 +180	40 / 450	bimetal (klixon)	69	21
TRIFASE THREE-PHASE	049100	1.1	200-240 Δ 345-415 Y	50	5,2 Δ 3 Y	2800	-145 +145	-	bimetal (klixon)	68	19
	049100	1.3	220-275 Δ 380-480 Y	60	5.5 Δ 3.2 Y	3400	-135 +135	-	bimetal (klixon)	69	19
	048111	1.5	200-240 Δ 345-415 Y	50	6.9 Δ 4 Y	2850	-185 +185	-	bimetal (klixon)	68	21
	048111	1.75	220-275 Δ 380-480 Y	60	7.1 Δ 4.1 Y	3450	-185 +175	-	bimetal (klixon)	69	21
	048055	2.2	230 Δ 400 Y	50	9 Δ 5.2 Y	2850	-215 +265	-	bimetal (klixon)	68	24
	048055	2.55	265 Δ 460 Y	60	9 Δ 5.2 Y	3450	-255 +275	-	bimetal (klixon)	69	24

* Livello di pressione sonora rilevato secondo le Norme ISO 3746 - 1979 (E). Parametri: r=1 - Rumore di fondo 51 dB (A) - Strumento: Brüel & Kjær type 2232.

* Sound pressure level tested according to ISO regulation 3746 - 1979 (E). Parameters: r=1 - Background noise 51 dB (A) - Instrument: Brüel & Kjær type 2232.

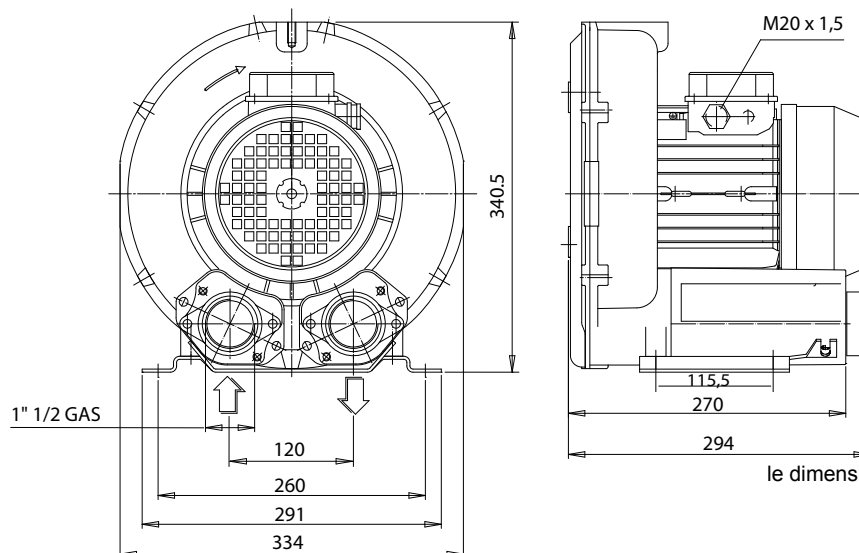
dimensioni:
dimensions:

le dimensioni sono espresse in millimetri
all dimensions are in mm

ASPIRAZIONE VACUUM

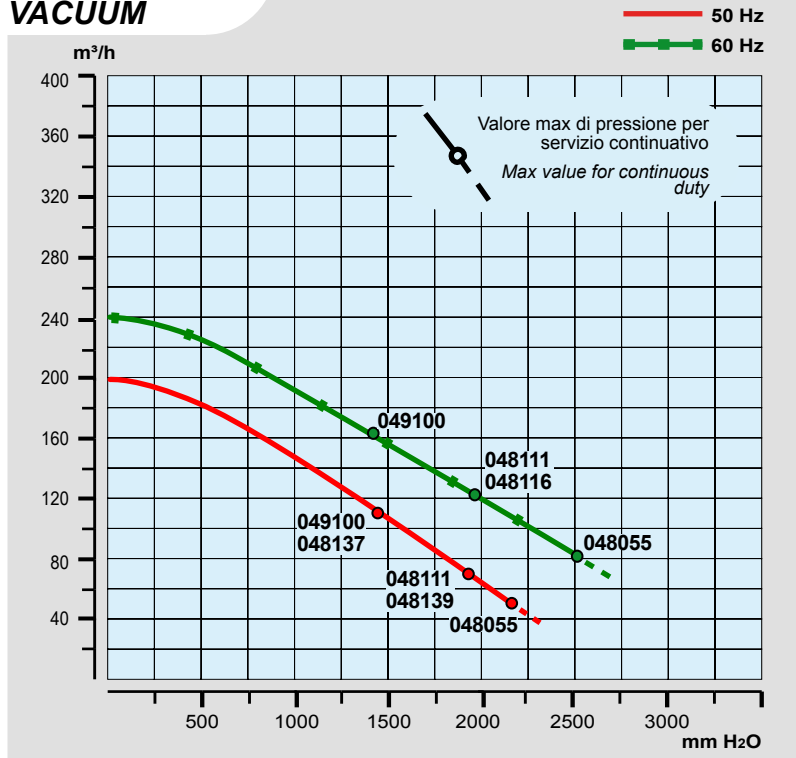

ASSORBIMENTO MOTORE MOTOR ABSORPTION

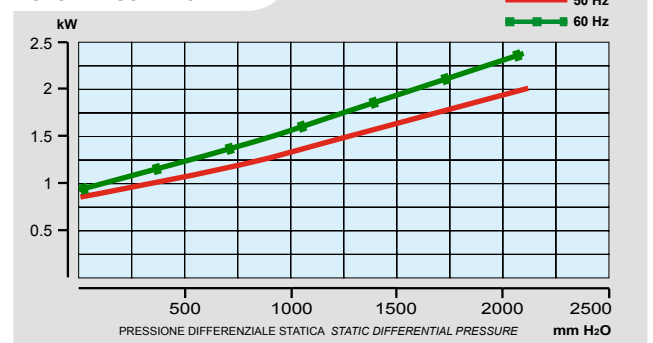

INCREMENTO TEMPERATURA ARIA AIR TEMPERATURE INCREASE

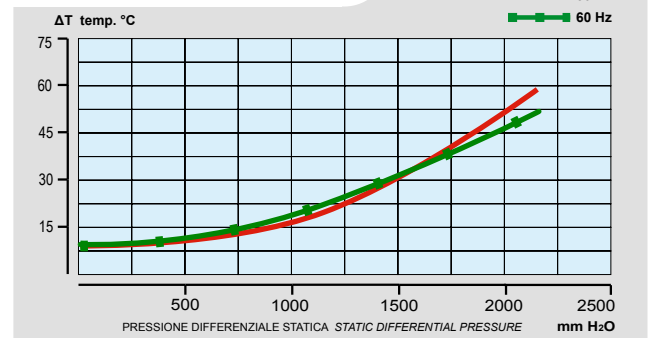

COMPRESSIONE PRESSURE

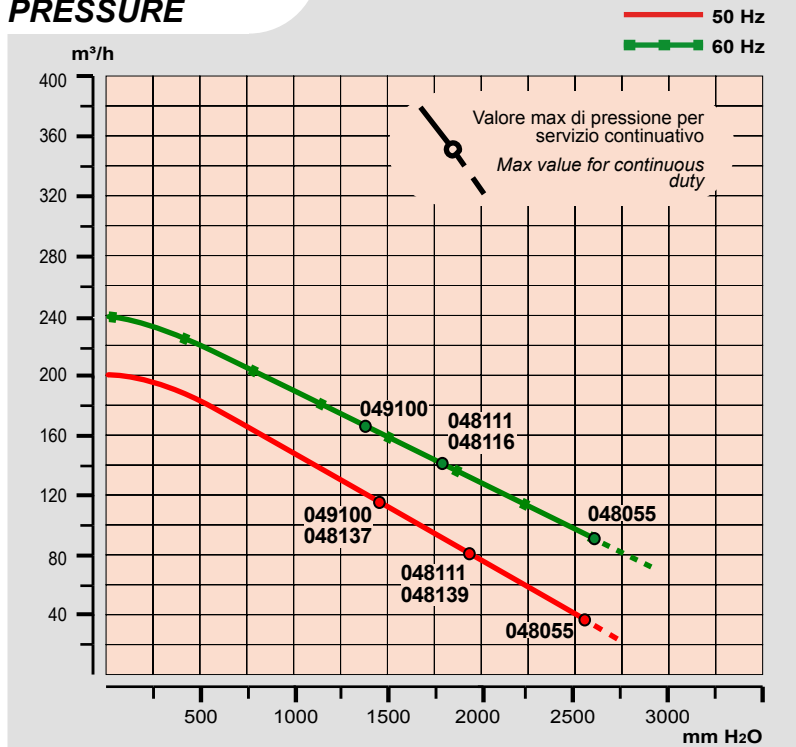

ASSORBIMENTO MOTORE MOTOR ABSORPTION

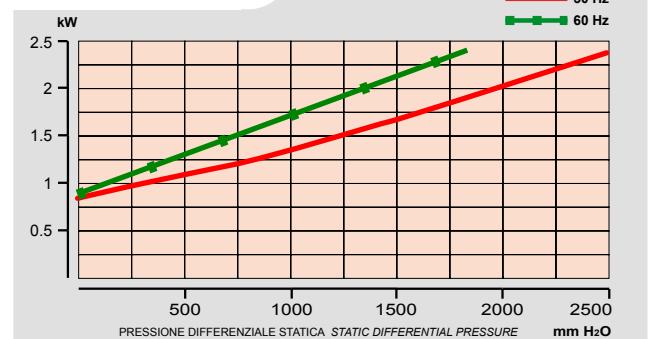

INCREMENTO TEMPERATURA ARIA AIR TEMPERATURE INCREASE

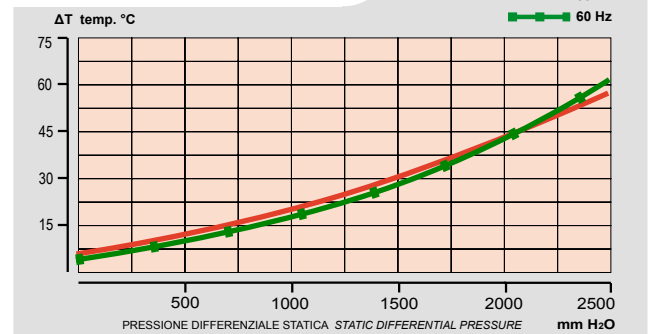

Tutti i dati della presente scheda tecnica si intendono indicativi e potranno essere modificati dalla casa in qualsiasi momento senza nessun preavviso.

La curva di aspirazione è riferita ad aria alla temperatura media di 20 °C e 1013 mbar sul raccordo di mandata.
La curva di compressione è riferita ad aria alla temperatura media di 20 °C e 1013 mbar sul raccordo di aspirazione.

All data is intended as an indication and may be modified without prior notice.

The vacuum curve is valid for pumping air, with a temperature of 20°C at the inlet flange and with a pressure of 1013 mbar at the discharge port.
The pressure curve is valid for pumping air, with an average temperature of 20°C and 1013 mbar at the inlet flange.

l/min = m³/h · 16,667
CFM = m³/h · 0,588
mbar = mm H₂O · 0,098
PSI = mm H₂O · 0,00142