



FC AT

Torrini di estrazione centrifughi per aria ad alte temperature (200°C) Single speed centrifugal roof fans for high temperature air (200°C)



La serie non rientra nel campo di applicazione della Direttiva ErP 2009/125/CE e successivi regolamenti

The series is not affected by ErP Directive 2009/125/CE and further Regulations

DESCRIZIONE

Torrini centrifughi a singola velocità destinati all'aspirazione, diretta o canalizzata, nelle più svariate applicazioni civili, industriali e commerciali. Caratterizzati da una notevole semplicità d'installazione, si distinguono per l'elevata silenziosità ed efficienza. Il motore è separato dal flusso d'aria convogliato, questo permette di poter aspirare aria pulita con temperatura da +65°C a max 200°C in continuo.

COSTRUZIONE

- Telaio di base in lamiera d'acciaio zincato.
- Rete di protezione in tondino d'acciaio trafilato e protetto contro gli agenti atmosferici. Realizzata a norme UNI EN 12499.
- Girante a pale rovesce autopulenti, ad alto rendimento aeraulico e bassa rumorosità, in lamiera zincata, bilanciata staticamente e dinamicamente secondo ISO 1940.
- Copertura in alluminio, con idonee feritoie per il corretto raffreddamento del motore.

MOTORE

Motore asincrono trifase IE3 a norme internazionali IEC 60034, IEC 60072, EMC 2014/30/UE, LVD 2014/35/UE, marcato CE, IP55, classe F.

ACCESSORI

- TS - Serranda a gravità in aspirazione
- GR - Silenziatore
- CB - Controbase a murare
- BA - Basi d'appoggio su coperture ondulate
- RA - Rete lato aspirazione
- Interruttore di servizio
- CCr - Rete di protezione piana.

DESCRIPTION

Single-speed centrifugal roof fans designed for direct or ducted ventilation in residential, commercial and industrial buildings. They are designed for easy installation, high efficiency low noise level.

The motor is outside the air flow, this allows the fan to exhaust clean with a temperature range from +65°C up to 200°C in continuous.

CONSTRUCTION

- Base frame in galvanized steel sheet.
- Protection guard in drawn steel rod protected against the atmospheric agents, manufactured according to UNI EN 12499.
- Backward curved wheel in galvanized steel sheet, with high efficiency and low noise level, statically and dynamically balanced according ISO 1940.
- Upper cover in aluminium, with appropriate slots for motor cooling.

MOTOR

Asynchronous three-phase motor IE3 manufactured according to international standards IEC 60034, IEC 60072, EMC 2014/30/UE, LVD 2014/35/UE, CE marked, IP 55, class F.

ACCESSORIES

- TS - Backdraught gravity shutter
- GR - Silencer
- CB - Counterbase
- BA - Support base for wawed roof coverings
- RA - Inlet Protection Guard
- Service switch
- CCr - Flat protection guard.

VERSIONI | VERSIONS



FC

Versione per temperatura aria standard di 100°C
Version for standard air temperature of 100°C



FC HT

Versioni per l'estrazione dei fumi d'incendio, certificata F400 secondo la EN12101-3:2015
Version for smoke extraction certified F400 according to EN12101-3:2015



FC ATEX

Versione antideflagrante secondo la Direttiva 2014/34/UE
Explosion-proof version according to Directive 2014/34/UE

PRESTAZIONI | PERFORMANCE

FC AT

Le prestazioni aerauliche sono rilevate in conformità alla norma EN ISO 5801/AMCA 210 con densità dell'aria standard avente peso specifico 1,2 Kg/m³. Alimentazione 230V/1Ph/50Hz o 400V/3Ph/50Hz. Air performances measured according to EN ISO 5801 / AMCA 210 standard with air density with 1.2 Kg/m³ specific weight. Power supply 230V/1Ph/50Hz or 400V/3Ph/50Hz.

Lp Livello di pressione sonora rilevato in condizioni di campo libero, propagazione semisferica, categoria di misura C a norma EN ISO 13349, nel punto di massimo rendimento, alla distanza di 6 metri e si presenta solo per fini comparativi. Sound pressure level measured in free field conditions, propagation hemispherical, measurement category C in accordance with EN ISO 13349, at the point of maximum efficiency, at a distance of 6 meters (for comparative purposes only).

Lw Livello di potenza sonora ottenuto secondo norma ISO 3746. Tolleranza +/- 3 dB(A). Sound power level obtained in accordance with EN ISO 3746. Tolerance +/- 3 dB(A).

FC AT 350

Code	Tipo Type	Modello Model	U	P	Pm (kW)	In (A)	iP/CL	IE3	Mot. Gr.
1FC3622	FC AT	354	T	4	0,25	0,85	55/F	-	71

LIVELLI SONORI | SOUND LEVELS dB(A)

Hz		63	125	250	500	1000	2000	4000	8000	TOT
354	Lw	48,2	61,9	68,1	72,9	73,0	69,5	64,6	53,9	77,7
	Lp	24,7	38,4	44,5	49,3	49,4	46,0	41,1	30,3	54,2

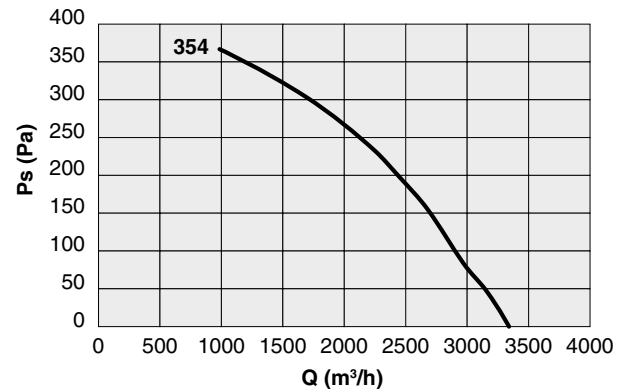

FC AT 400

Code	Tipo Type	Modello Model	U	P	Pm (kW)	In (A)	iP/CL	IE3	Mot. Gr.
1FC4121	FC AT	404	T	4	0,55	1,60	55/F	-	80

LIVELLI SONORI | SOUND LEVELS dB(A)

Hz		63	125	250	500	1000	2000	4000	8000	TOT
404	Lw	50,8	64,5	71,5	74,1	74,9	72,0	68,5	57,1	79,9
	Lp	27,2	40,9	47,9	50,6	51,3	48,5	44,9	33,5	56,3

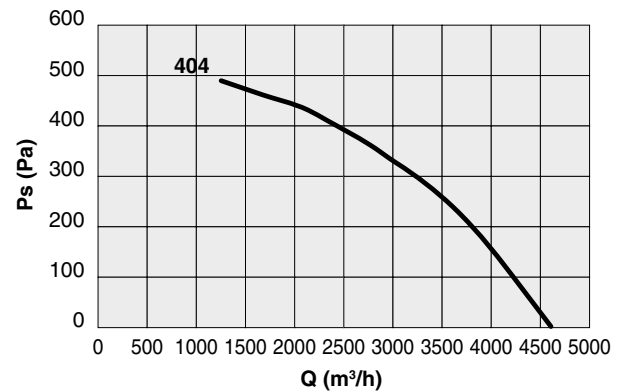

FC AT 450

Code	Tipo Type	Modello Model	U	P	Pm (kW)	In (A)	iP/CL	IE3	Mot. Gr.
1FC4523	FC AT	454	T	4	0,75	2,10	55/F	✓	80

LIVELLI SONORI | SOUND LEVELS dB(A)

Hz		63	125	250	500	1000	2000	4000	8000	TOT
454	Lw	52,0	65,5	73,4	76,3	76,2	73,2	68,8	58,4	81,4
	Lp	28,5	42,0	49,8	52,7	52,7	49,7	45,2	34,8	57,9

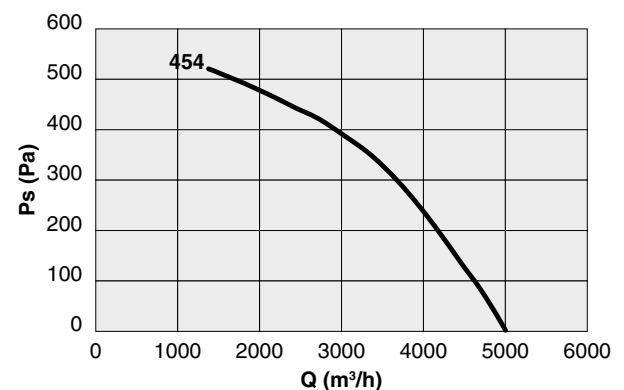

SEZ.
1.11

FC AT 500

Code	Tipo Type	Modello Model	U	P	Pm (kW)	In (A)	iP/CL	IE3	Mot. Gr.
1FC5021	FC AT	504	T	4	1,1	2,5	55/F	✓	90S

LIVELLI SONORI | SOUND LEVELS dB(A)

Hz		63	125	250	500	1000	2000	4000	8000	TOT
504	Lw	51,6	67,4	74,9	78,1	79,2	76,9	71,8	61,2	84,0
	Lp	28,0	43,9	51,3	54,5	55,6	53,3	48,2	37,7	60,4

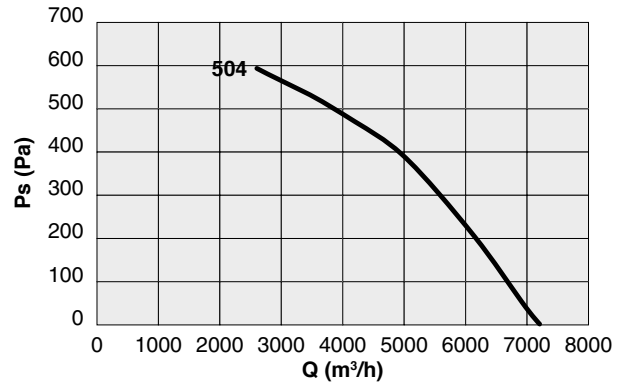

FC AT 560

Code	Tipo Type	Modello Model	U	P	Pm (kW)	In (A)	iP/CL	IE3	Mot. Gr.
1FC5621	FC AT	566	T	6	0,55	1,80	55/F	-	80

LIVELLI SONORI | SOUND LEVELS dB(A)

Hz		63	125	250	500	1000	2000	4000	8000	TOT
566	Lw	48,2	58,2	67,3	70,3	71,4	69,2	62,1	52,4	76,1
	Lp	24,6	34,7	43,7	46,7	47,8	45,6	38,5	28,8	52,5

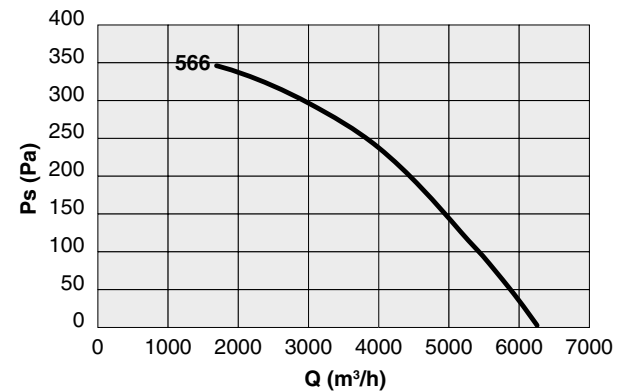

FC AT 630

Code	Tipo Type	Modello Model	U	P	Pm (kW)	In (A)	iP/CL	IE3	Mot. Gr.
1FC6321	FC AT	636	T	6	1,1	2,80	55/F	✓	90L

LIVELLI SONORI | SOUND LEVELS dB(A)

Hz		63	125	250	500	1000	2000	4000	8000	TOT
636	Lw	56,9	67,9	74,1	76,2	77,4	75,3	69,1	59,6	82,3
	Lp	33,3	44,3	50,5	52,6	53,8	51,8	45,6	36,0	58,8

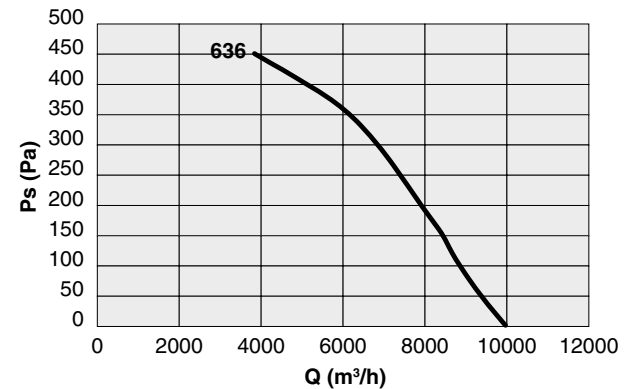

FC AT 750

Code	Tipo Type	Modello Model	U	P	Pm (kW)	In (A)	iP/CL	IE3	Mot. Gr.
1FC7521	FC AT	756	T	6	2,2	5,00	55/F	✓	112M

LIVELLI SONORI | SOUND LEVELS dB(A)

Hz		63	125	250	500	1000	2000	4000	8000	TOT
756	Lw	58,2	70,5	77,2	80,4	81,3	79,3	74,4	66,1	86,3
	Lp	34,6	46,9	53,7	56,8	57,8	55,7	50,9	42,6	62,7

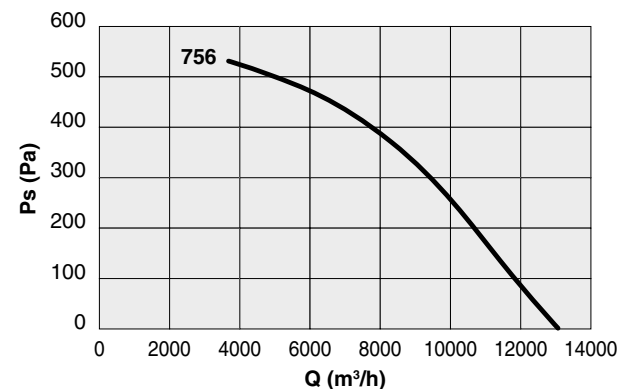

PRESTAZIONI | PERFORMANCE

FC AT

FC AT 800

Code	Tipo Type	Modello Model	U	P	Pm (kW)	In (A)	iP/CL	IE3	Mot. Gr.
1FC8105	FC AT	806	T	6	3	6,20	55/F	✓	132S

LIVELLI SONORI | SOUND LEVELS dB(A)

Hz		63	125	250	500	1000	2000	4000	8000	TOT
806	Lw	61,1	76,6	82,4	86,6	85,7	87,0	84,8	76,0	92,8
	Lp	37,5	53,1	58,9	63,0	62,2	63,4	61,3	52,4	69,2

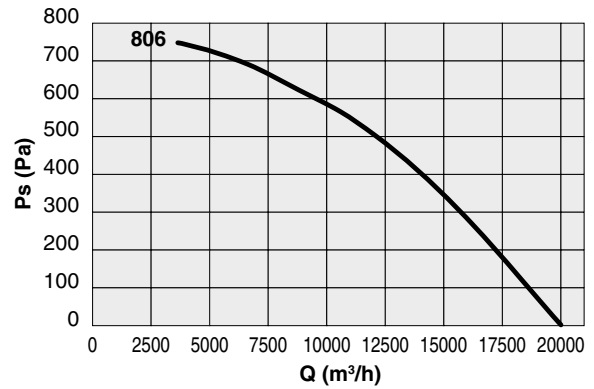

DIMENSIONI | DIMENSIONS mm

FC AT

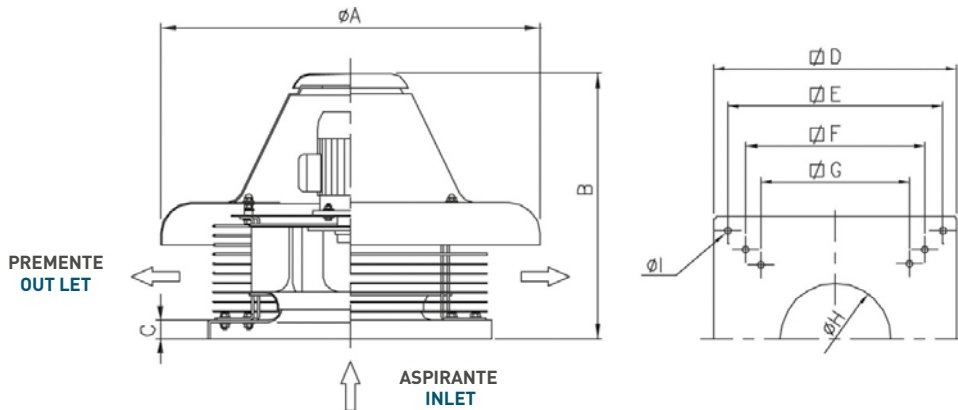

FC AT

TIPO TYPE	ØA	B	C	ØD	ØE	ØF	ØG	ØH	ØI	Kg*
350	815	540	38	500	450	-	380	270	12	30
400	815	590	38	650	600	530	471	296	12	35
450	815	590	38	650	600	530	471	296	12	43
500	965	670	38	760	710	650	550	320	14	60
560	965	670	38	760	710	650	550	370	14	63
630	1110	810	38	930	870	775	665	430	14	80
750	1110	850	38	930	870	775	665	480	14	125
800	1110	950	38	930	870	775	665	530	14	145

*Pesi indicativi | Indicative weights

SEZ.
1.11

FC AT torrini | roof fans



GR | SILENZIATORI | SILENCERS

Silenziatori con setto centrale, riducono la rumorosità del torrino. Materiale fonoassorbente in lana minerale. Struttura portante in lamiera zincata. Attenzione: l'utilizzo del silenziatore abbinato alla serranda TS, l'utilizzo della versione con setto ribassato.

Silencers with central pod. They reduce the noise of the fan. Sound absorbing material: mineral wool. Frame in galvanized steel sheet. Attention: the use of a Silencer together with a TS shutter requires the use of the silencer with lowered pod.

Code (I)	Code (II)	Tipo Type	A	B	B ribassato lowered	C	D	E	F	G	ØH	Kg
1S10350	1S10457	GR 35	750	650	400	490	450	120	150	50	M8	37
1S10400	1S10454	GR 40	750	650	350	640	600	145	250	50	M8	42
1S10400	1S10454	GR 45	750	650	350	640	600	145	250	50	M8	42
1S10560	1S10458	GR 50	750	650	300	750	710	200	250	50	M10	42
1S10560	1S10458	GR 56	750	650	300	750	710	210	250	50	M10	50
1S10630	1S10691	GR 63	1000	800	500	920	870	210	400	50	M10	79
1S10630	1S10691	GR 75	1000	800	500	920	870	210	400	50	M10	79
1S10630	1S10851	GR 80	1000	800	500	1080	1030	980	400	50	M10	79

(I) Versione standard | Standard version - (II) Versione con setto ribassato | Version with lowered pod

ATTENUAZIONE IN dB PER BANDA DI OTTAVA (Hz) OCTAVE (Hz) SPECTRUM OF NOISE ATTENUATION IN dB

Tipo Type	63	125	250	500	1000	2000	4000	8000
GR 25	2	4	6	10	16	18	15	11
GR 31	2	4	6	10	16	18	15	11
GR 35	3	5	9	11	19	20	18	14
GR 40	3	4	8	9	18	15	10	6
GR 45	3	4	8	9	18	15	10	6
GR 50	4	5	11	15	16	12	9	5
GR 56	4	5	11	15	16	12	9	5
GR 63	3	4	5	8	14	9	7	3
GR 75	3	4	5	8	14	9	7	3
GR 80	3	4	5	8	14	9	7	3

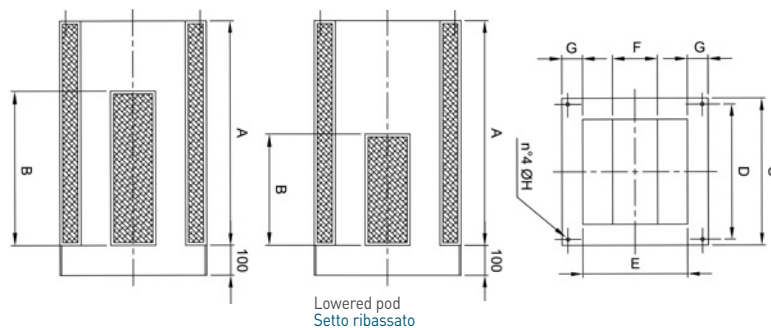

TS | SERRANDE A GRAVITÀ | GRAVITY SHUTTER

Evitano inutili dispersioni di calore e richiedono un'irrelevante perdita di carico. Le alette della serranda si aprono con la depressione dell'aria generata dal ventilatore in moto e si chiudono per gravità al suo spegnimento. La struttura è realizzata in lamiera zincata. Nel caso di utilizzo con silenziatore, utilizzare la versione di silenziatore con setto ribassato.

They avoid heat dispersion through the roof when this fan is not working with a negligible opening pressure. The shutter flaps are opened by the air depression produced by the fan when working, and they shut down by gravity after switching-off. The structured is made in galvanized steel sheet. In case of use with silencer, the version of silencer with lowered pod has to be used.

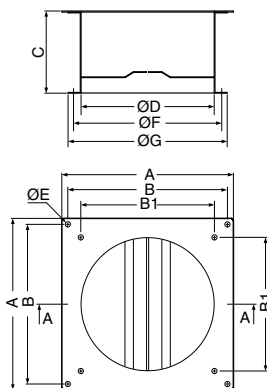

Code	Tipo Type	A	B	B1	C	ØD	ØE	ØF	ØG	Kg
1TS3510 (II)	TS 35	465	380	-	222	402	10	438	464	5,0
1TS4010	TS 40/45	500	471	-	222	402	10	438	464	6,0
1TS5510	TS 50/56	640	550	-	257	569	12	605	639	9,5
1TS6510	TS 63/75/80	710	665	-	252	634	12	674	708	11,0

(II) Non compatibile con silenziatore 1S10350 o altri
Not compatible with silencer 1S10350 or others

CB | CONTROBASI A MURARE | COUNTER BASES TO BE WALLED UP

La controbase garantisce un efficace ancoraggio al cavedio, tramite la muratura delle quattro zanche appositamente realizzate. Manufatto realizzato in robusta lamiera con predisposto il fissaggio alla base del torrino.

The counter base ensures an effective anchorage to the concrete support, through the fixing of four metal strips suitably designed. It is made in solid steel with arrangement for fixing to the fan base.

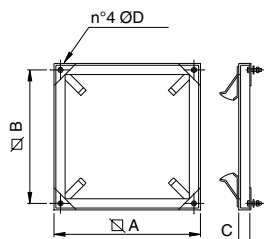

Code	Tipo Type	ØA	ØB	C	ØD	Kg
1CB3500	CB 35	490	450	30	M8X30	2,8
1CB4000	CB 40	630	600	30	M8X30	3,2
1CB4000	CB 45	630	600	30	M8X30	3,2
1CB5500	CB 50	740	710	30	M10X40	3,6
1CB5500	CB 56	740	710	30	M10X40	3,6
1CB6000	CB 63	900	870	30	M10X40	4,0
1CB6000	CB 75	900	870	30	M10X40	4,0
1CB6000	CB 80	900	870	30	M10X40	4,0



BA | BASE D'APPOGGIO PER TORRINI | SUPPORT BASE FOR ROOF FANS

DESCRIZIONE - Le basi d'appoggio BA e la riduzione RD sono adatte per l'installazione dei nostri torrini su coperture costruite in lastre ondulate, evitando dannosi ristagni d'acqua attorno al ventilatore e costose opere murarie o di carpenteria. La base d'appoggio BA è utilizzabile per torrini aventi basamento da 930x930. Con l'apposita riduzione RD è possibile utilizzare la base per basamenti di torrini fino ad un minimo di 500x500. La riduzione RD è un unico elemento dove con un semplice taglio si elimina la parte eccedente.

VERSIONI

- BA 10x177 (Cod. 5PL1008) La base è accoppiabile a lastre tipo "EURO" passo 177 mm, altezza 51 mm e pendenza falda pari al 10%.
- BA 3x177 (Cod. 5PL1015) La base è accoppiabile a lastre tipo "EURO" passo 177 mm, altezza 51 mm e raggio di curvatura lastra pari a 3 metri.
- BA 10x146 (Cod. 5PL1009) La base è accoppiabile a lastre tipo "INTERNAZIONALE" passo 146 mm, altezza 48 mm, pendenza falda pari al 10%.
- Riduzione RD (Cod. 5PL1010).

CONSTRUZIONE - In resine poliestere rinforzato con fibra di vetro stratificato. La finitura è RAL 9002 (grigio chiaro). La superficie esterna è trattata per resistere nel tempo agli agenti atmosferici.

POSA IN OPERA - Una posa corretta prevede la sovrapposizione alla lastra di copertura a valle e una sottoesposizione a monte. Inoltre è da prevedere una sovrapposizione laterale di almeno un onda e un quarto per lato.

DESCRIPTION - The support base BA and reduction RD are suitable for installation of roof fans on waved coverings, avoiding detrimental stagnation of water near to the fan and expensive carpentry works. The support base BA is suitable for roof fans having base 930 x 930 mm or bigger. With the suitable reduction RD it is possible to use the base for roof fans from a minimum base dimension of 500x500. The reduction RD is a single element that can be easily cut to fit the exact fan dimension.

VERSION

- BA 10x177 (Cod. 5PL1008): suitable for "EURO" roof coverings pitch 177, height 51 mm and 10% slope.
- BA 3x177 (Cod. 5PL1015): suitable for "EURO" roof coverings pitch 177 mm, height 51 mm and radius of curvature of the sheet of 3 meters.
- BA 10x146 (Cod. 5PL1009): suitable for "INTERNATIONAL" roof coverings pitch 146 mm, height 48 mm, and 10% slope.
- Reduction RD (Cod. 5PL1010).

CONSTRUCTION - In polyester resins strengthen with stratified fibre glass. The finishing is RAL 9002 (light grey). The external surface is treated against the action of atmospheric agent.

INSTALLATION - A correct fitting foresees the overlap to the covering slab downstream and the underexposure upstream. Furthermore it must be foreseen a side overlap of at least one and quarter wave for each side.

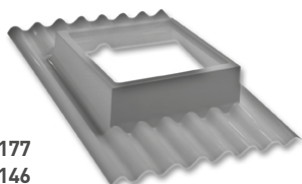

5PL1008 - BA 10x177
5PL1009 - BA 10x146

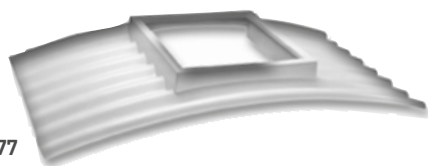
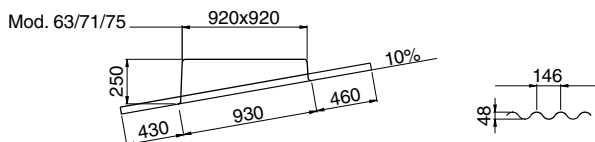

5PL1015 - BA 3x177

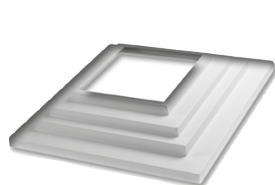
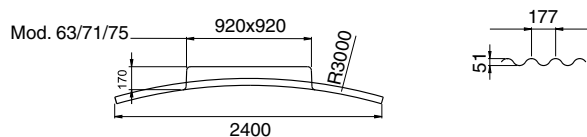

5PL1010 - RD

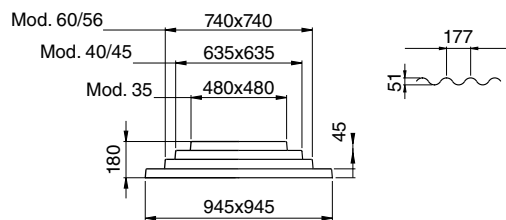
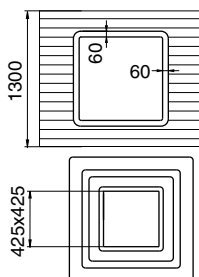

Dimensioni in mm | Dimensions in mm

CCr | RETE PROTEZIONE BOCCA ASPIRANTE | INLET PROTECTION GUARD

Salvaguardano dal contatto accidentale con le parti in movimento del ventilatore. Realizzate in filo d'acciaio, a norma UNI 12499 e protette contro gli agenti atmosferici.

They prevent from casual contact with moving parts of the fan. Manufactured in steel rod according to UNI 12499 standard and protected against atmospheric agents.

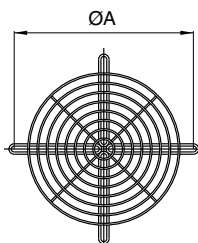

Code	Tipo Type	ØA	Kg
5RE9051	CCr 35	560	1,4
5RE9064	CCr 40-45	620	2,0
5RE9083	CCr 50-56	690	2,2
5RE9093	CCr 63-75		

Dimensioni in mm | Dimensions in mm