



PR-AC ATEX

Aspiratori centrifughi in materiale plastico Centrifugal fans in plastic material



Direttiva
ATEX 2014/34/UE

A RICHIESTA UPON REQUEST

- ATEX II3D
- Staffa porta-motore in acciaio inossidabile AISI 304
- ATEX II3D
- Version with motor support in stainless steel AISI 304.

VERSIONI | VERSIONS



PR-AC

Versione per sola aria corrosiva in atmosfera non esplosiva con temperatura dell'aria fino a 70°C
Version for corrosive air in non-explosive atmosphere with air temperature up to 70°C

DESCRIZIONE

La serie PR-AC ATEX è particolarmente adatta a convogliare fumi e vapori corrosivi (non abrasivi) o ad alto tasso d'umidità, con temperatura da -20°C a +40°C. L'utilizzo di specifici materiali e componenti rendono la serie PR-AC compatibile a installazioni rispondenti alle Direttiva 2014/34/UE. La sua installazione è particolarmente indicata negli impianti certificati ATEX categoria 3, zona 2-22 (3G). La girante a pale rovesce conferisce a questa serie buone caratteristiche di silenziosità ed efficienza aeraulica. PR-AC ATEX è un ventilatore centrifugo realizzato con tecnopolimeri aventi caratteristiche tecniche e meccaniche che permettono una maggiore longevità rispetto a vari tipi di metalli. Terminato il ciclo vitale, i materiali utilizzati sono totalmente riciclabili.

COSTRUZIONE

- Cassa a spirale realizzata in polietilene antistatico e autoestingente.
- Girante a semplice aspirazione, realizzata in polipropilene antistatica, con mozzo in alluminio protetto dal fluido convogliato.
- Staffa porta-motore realizzata in lamiera d'acciaio verniciata a polveri epossidiche.

MOTORE

Motore asincrono trifase ATEX per atmosfere esplosive Categoria G gruppo II classe termica T4 protezione Exd costruito secondo le norme internazionali IEC60034, IEC60072, IEC60079, e/o 61241, EMC 2014/30/UE, LVD 2014/35/UE, IP55, classe F, Forma B3 o B5, marchiati CE e certificato ATEX da ente notificato. Idoneo a servizio S1, funzionamento continuo a carico costante.

ACCESSORI

- Rete di protezione per bocca aspirante e premente realizzata a norma UNI 10615
- Giunto antivibrante in PVC per bocca aspirante e premente
- Serranda a gravità
- Serranda di taratura manuale.

DESCRIPTION

The PR-AC ATEX series is designed for conveying smoke and corrosive (not abrasive) or highly humid vapours with temperature from -20°C to +40°C. The use of specific materials and components make PR-AC ATEX suitable for installation in plant certified according to the ATEX Directive 2014/34/EU. Their installation is particularly indicated in ATEX category 3, zone 2-22 (3G). The backward curved impeller provide good characteristics of low noise and high efficiency. The PR-AC ATEX fan, when its lifetime is finished, is easy to dispose, being manufactured with recyclable materials. Besides, such materials guarantee a longer life cycle in comparison to different types of metals.

CONSTRUCTION

- Volute in polyethylene.
- Single inlet impeller, in Polypropylene, with backward curved blades and aluminium hub (protected from the fluid).
- Motor support in epoxy painted steel sheet.

MOTOR

Asynchronous three-phase or single-phase ATEX motors for explosive atmospheres category G group II thermal class T4 protection Exd according to international standards IEC 60034, IEC 60072, EMC 2014/30/UE, LVD 2014/35/UE, marked, IP 55, class F, B3 or B5 shape. Suitable to a S1 service (continuous working to constant load).

ACCESSORIES

- Inlet protection guard according to UNI 10615
- Anti-vibration joint in PVC for inlet and outlet sides
- Gravity shutter
- Manual setting shutter.

PRESTAZIONI | PERFORMANCE

PR-AC ATEX

Le prestazioni aerauliche sono rilevate in conformità alla norma EN ISO 5801/AMCA 210 con densità dell'aria standard avente peso specifico 1,2 Kg/m³. Alimentazione 230V/1Ph/50Hz o 400V/3Ph/50Hz. Air performances measured according to EN ISO 5801 / AMCA 210 standard with air density with 1,2 Kg/m³ specific weight. Power supply 230V/1Ph/50Hz or 400V/3Ph/50Hz.

Lp Livello di pressione sonora rilevato in condizioni di campo libero, propagazione sferica, categoria di misura C a norma EN ISO 13349, nel punto di massimo rendimento, alla distanza di 1,5 metri dal lato aspirazione e si presenta solo per fini comparativi. Sound pressure level measured in free field conditions, propagation spherical, measurement category C in accordance with EN ISO 13349, at the point of maximum efficiency at a distance of 1,5 meters, inlet side (for comparative purposes only).

Lw Livello di potenza sonora ottenuto secondo norma ISO 3746. Tolleranza +/- 3 dB(A). Sound power level obtained in accordance with EN ISO 3746. Tolerance +/- 3 dB(A).

PR-AC ATEX 200

Code	Tipo Type	Modello Model	U	P	Pm (kW)	In (A)	IP/CL	IE3	Mot. (Gr)
7PA2106	PR-AC ATEX	202	T	2	0,18	0,70	55/F	-	63

LIVELLI SONORI | SOUND LEVELS dB(A)

Hz		63	125	250	500	1000	2000	4000	8000	TOT
202	Lw	77,3	79,3	77,3	78,3	74,3	69,3	61,3	53,3	85
	Lp	63	65	63	64	60	55	47	39	70

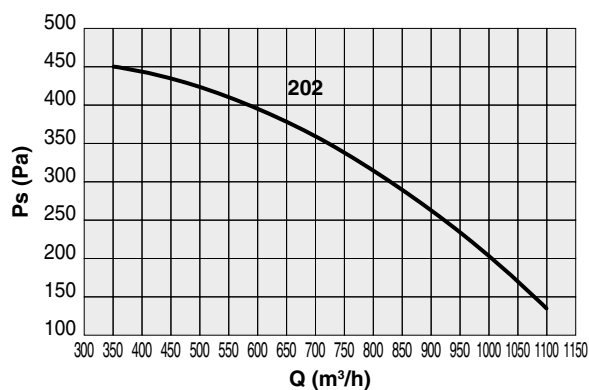

PR-AC ATEX 250

Code	Tipo Type	Modello Model	U	P	Pm (kW)	In (A)	IP/CL	IE3	Mot. (Gr)
7PA2632	PR-AC ATEX	252	T	2	0,37	1,20	55/F	-	71
7PA2633		254	T	4	0,12	0,74	55/F	-	63

LIVELLI SONORI | SOUND LEVELS dB(A)

Hz		63	125	250	500	1000	2000	4000	8000	TOT
252	Lw	84,2	86,2	84,2	85,2	81,2	76,2	68,2	60,2	92
	Lp	70	72	70	71	67	62	54	46	77
254	Lw	69,3	71,3	72,3	67,3	66,3	61,3	53,3	45,3	77
	Lp	55	57	58	53	52	47	39	31	62

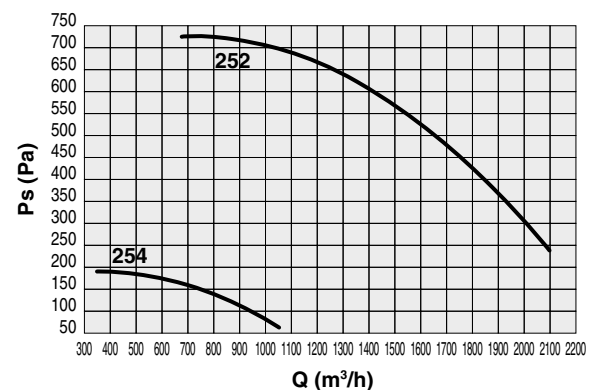

PR-AC ATEX 280

Code	Tipo Type	Modello Model	U	P	Pm (kW)	In (A)	IP/CL	IE3	Mot. (Gr)
7PA2894	PR-AC ATEX	282	T	2	0,75	2,00	55/F	✓	80
7PA2895		284	T	4	0,18	0,84	55/F	-	63

LIVELLI SONORI | SOUND LEVELS dB(A)

Hz		63	125	250	500	1000	2000	4000	8000	TOT
282	Lw	88	90	88	89	85	80	72	64	95
	Lp	73	75	73	74	70	65	57	49	81
284	Lw	73	75	76	71	70	65	57	49	81
	Lp	58	60	61	56	55	50	42	34	66

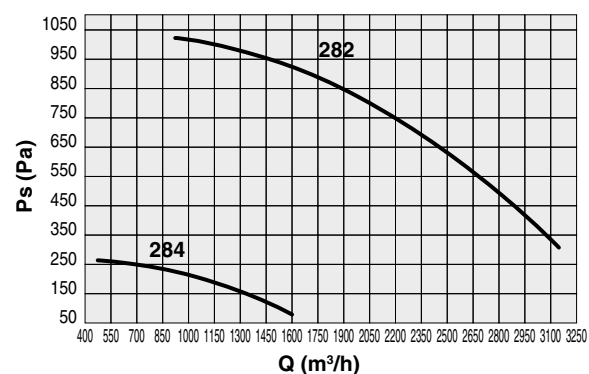

PR-AC ATEX 310

Code	Tipo Type	Modello Model	U	P	Pm (kW)	In (A)	IP/CL	IE3	Mot. (Gr)
7PA3230		312	T	2	1,50	3,60	55/F	✓	90S
7PA3231	PR-AC ATEX	314	T	4	0,25	1,20	55/F	-	71
7PA3232		316	T	6	0,18	1,00	55/F	-	71

LIVELLI SONORI | SOUND LEVELS dB(A)

Hz	Hz	63	125	250	500	1000	2000	4000	8000	TOT
312	Lw	90,7	92,7	90,7	91,7	87,7	82,7	74,7	66,7	98
	Lp	76	78	76	77	73	68	60	52	84
314	Lw	75,7	77,7	78,7	73,7	72,7	67,7	59,7	51,7	83
	Lp	61	63	64	59	58	53	45	37	69
316	Lw	65,2	70,2	65,2	63,2	62,2	57,2	49,2	41,2	73
	Lp	51	56	51	49	48	43	35	27	59

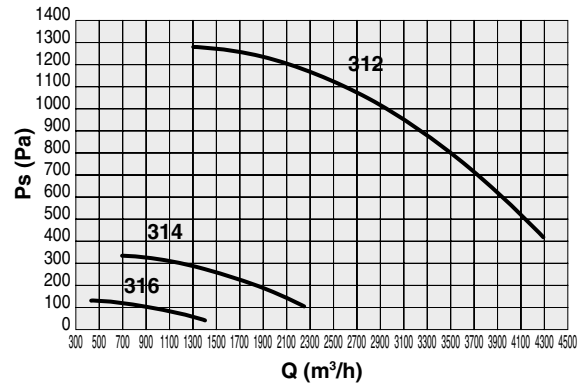

PR-AC ATEX 350

Code	Tipo Type	Modello Model	U	P	Pm (kW)	In (A)	IP/CL	IE3	Mot. (Gr)
7PA3629		352	T	2	2,20	5,00	55/F	✓	90L
7PA3630	PR-AC ATEX	354	T	4	0,37	1,50	55/F	-	71
7PA3631		356	T	6	0,18	1,00	55/F	-	71

LIVELLI SONORI | SOUND LEVELS dB(A)

Hz	Hz	63	125	250	500	1000	2000	4000	8000	TOT
352	Lw	92,2	94,2	92,2	93,2	89,2	84,2	76,2	68,2	100
	Lp	78	80	78	79	75	70	62	54	85
354	Lw	77,2	79,2	80,2	75,2	74,2	69,2	61,2	53,2	85
	Lp	63	65	66	61	60	55	47	39	70
356	Lw	66,7	71,7	66,7	64,7	63,7	58,7	50,7	42,7	75
	Lp	52	57	52	50	49	44	36	28	60

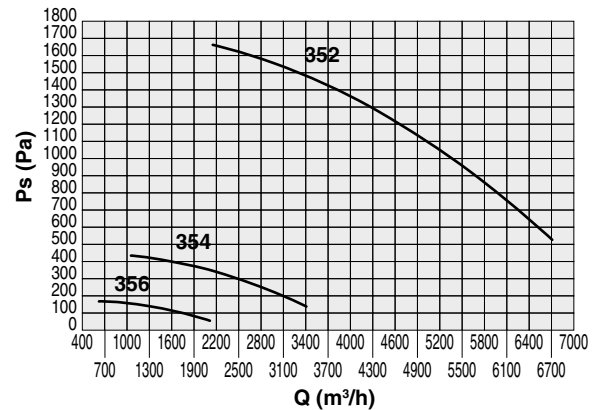

PR-AC ATEX 400

Code	Tipo Type	Modello Model	U	P	Pm (kW)	In (A)	IP/CL	IE3	Mot. (Gr)
7PA4101		404	T	4	0,55	1,70	55/F	-	80
7PA4102	PR-AC ATEX	406	T	6	0,25	1,40	55/F	-	71

LIVELLI SONORI | SOUND LEVELS dB(A)

Hz	Hz	63	125	250	500	1000	2000	4000	8000	TOT
404	Lw	81,5	83,5	84,5	79,5	78,5	73,5	65,5	57,5	89
	Lp	67	69	70	65	64	59	51	43	75
406	Lw	72,1	77,1	72,1	70,1	69,1	64,1	56,1	48,1	80
	Lp	58	63	58	56	55	50	42	34	66

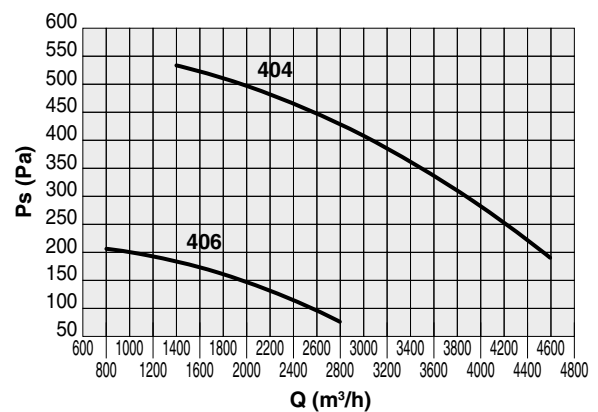

PR-AC ATEX 450

Code	Tipo Type	Modello Model	U	P	Pm (kW)	In (A)	IP/CL	IE3	Mot. (Gr)
7PA4605	PR-AC ATEX	454	T	4	1,10	3,00	55/F	✓	90S
7PA4606		456	T	6	0,37	1,60	55/F	-	80

LIVELLI SONORI | SOUND LEVELS dB(A)

Hz		63	125	250	500	1000	2000	4000	8000	TOT
454	Lw	81,6	83,6	84,6	79,6	78,6	73,6	65,6	57,6	89
	Lp	67	69	70	65	64	59	51	43	75
456	Lw	72,3	77,3	72,3	70,3	69,3	64,3	56,3	48,3	80
	Lp	58	63	58	56	55	50	42	34	66

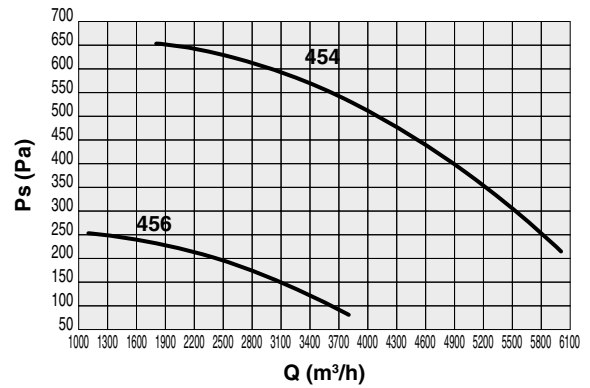

PR-AC ATEX 500

Code	Tipo Type	Modello Model	U	P	Pm (kW)	In (A)	IP/CL	IE3	Mot. (Gr)
7PA5066	PR-AC ATEX	504	T	4	2,20	5,20	55/F	✓	100L
7PA5067		506	T	6	0,55	2,00	55/F	-	90S

LIVELLI SONORI | SOUND LEVELS dB(A)

Hz		63	125	250	500	1000	2000	4000	8000	TOT
504	Lw	89	91	92	87	86	81	73	65	97
	Lp	74	76	77	72	71	66	58	50	82
506	Lw	79,6	81,6	82,6	77,6	76,6	71,6	63,6	55,6	87
	Lp	65	67	68	63	62	57	49	41	73

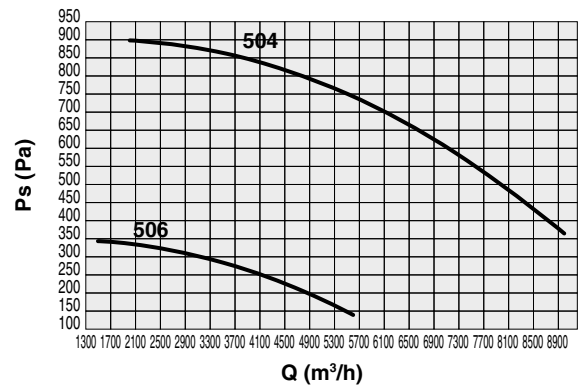

PR-AC ATEX 560

Code	Tipo Type	Modello Model	U	P	Pm (kW)	In (A)	IP/CL	IE3	Mot. (Gr)
7PA5665	PR-AC ATEX	564	T	4	4,00	9,10	55/F	✓	112M
7PA5666		566	T	6	1,50	4,40	55/F	✓	100L

LIVELLI SONORI | SOUND LEVELS dB(A)

Hz		63	125	250	500	1000	2000	4000	8000	TOT
564	Lw	88,5	90,5	91,5	86,5	85,5	80,5	72,5	64,5	96
	Lp	74	76	77	72	71	66	58	50	82
566	Lw	79,1	81,1	82,1	77,1	76,1	71,1	63,1	55,1	87
	Lp	65	67	68	63	62	57	49	41	72

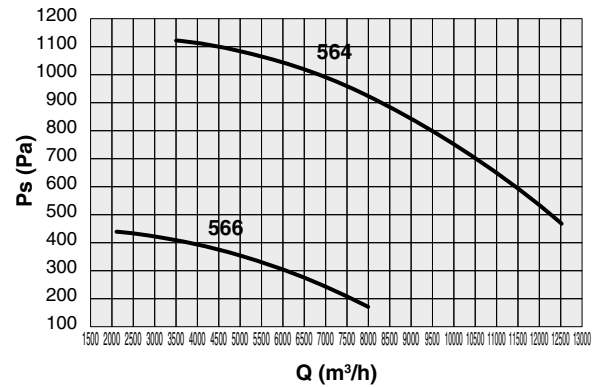

PR-AC ATEX 630

Code	Tipo Type	Modello Model	U	P	Pm (kW)	In (A)	IP/CL	IE3	Mot. (Gr)
7PA6357	PR-AC ATEX	634	T	4	5,50	12,00	55/F	✓	112M
7PA6358		636	T	6	2,20	5,40	55/F	✓	132S

LIVELLI SONORI | SOUND LEVELS dB(A)

Hz		63	125	250	500	1000	2000	4000	8000	TOT
634	Lw	88,3	90,3	91,3	86,3	85,3	80,3	72,3	64,3	96
	Lp	74	76	77	72	71	66	58	50	81
636	Lw	78,9	80,9	81,9	76,9	75,9	70,9	62,9	54,9	87
	Lp	64	66	67	62	61	56	48	40	72

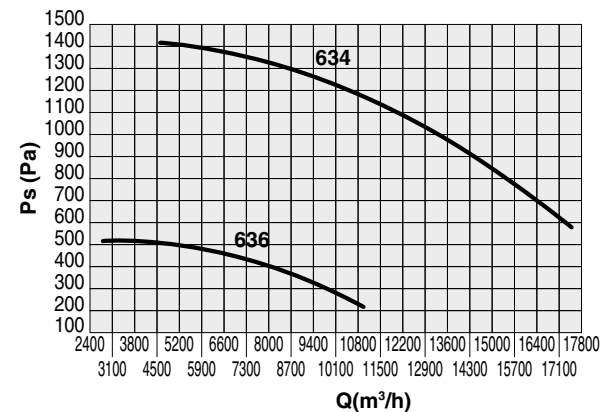

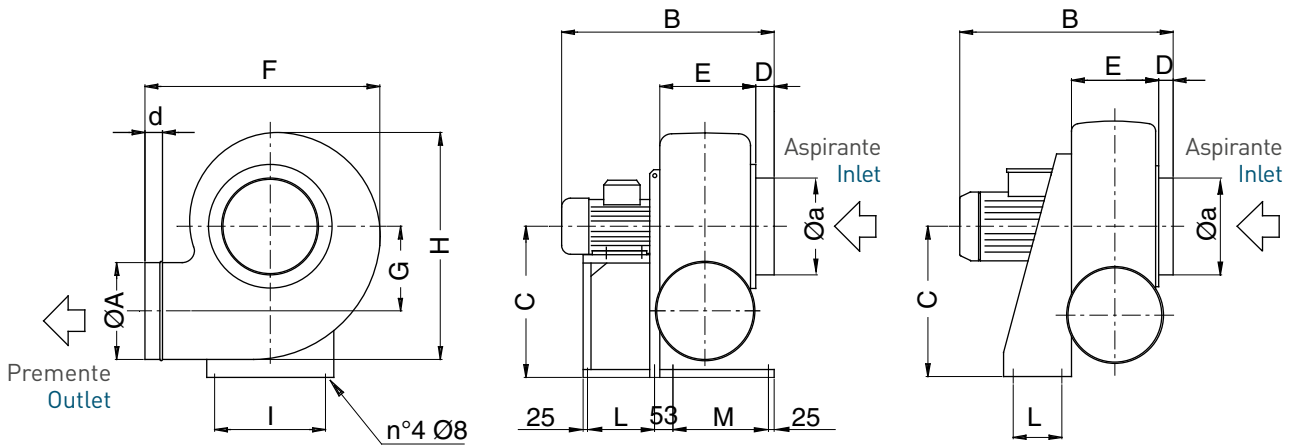

PR-AC ATEX 50 - 56 - 63

PR-AC ATEX 20 - 25 - 28 - 31 - 35 - 40 - 45

PR-AC ATEX

TIPO TYPE	ØA	Øa	B	C	D	d	E	F	G	H	I	L	M	Kg
PR-AC ATEX 20	160	160	385	250	35	40	157	373	140	370	200	100	-	17
PR-AC ATEX 25	200	200	435	310	35	45	180	452	173	465	255	100	-	24
PR-AC ATEX 28	225	225	470	350	40	35	192	515	208	530	280	120	-	33
PR-AC ATEX 31	250	250	527	410	40	40	197	560	240	595	320	150	-	45
PR-AC ATEX 35	280	280	565	445	40	40	234	600	260	670	355	150	-	51
PR-AC ATEX 40	315	315	530	516	40	35	248	675	290	742	330	170	-	47
PR-AC ATEX 45	355	355	614	550	40	40	283	750	324	830	368	170	-	61
PR-AC ATEX 50	400	400	730	630	50	60	355	840	360	955	290	237	335	77
PR-AC ATEX 56	450	450	760	710	50	60	375	930	410	1045	289	270	454	120
PR-AC ATEX 63	500	500	887	800	50	60	445	1110	450	1200	337	270	505	131

Pesi indicativi | Indicative weights

ORIENTAMENTI | DISCHARGE ANGLES

Rotazione Rotation RD						
Forma Form	0°	45°	90°	135°	270°	315°
Rotazione Rotation LG						

N.B.: Orientamento standard LG270° | Standard discharge angles LG 270°

PR-AC ATEX aspiratori | fans



5SU | GIUNTO ANTIVIBRANTE | ANTIVIBRATION JOINT

.Per bocca aspirante e premente, in PVC
.Rinlet and outlet, in PVC

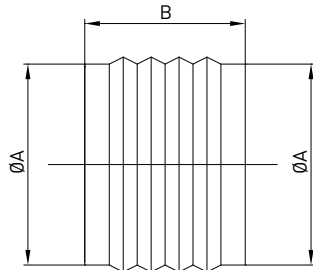

Code	Tipo Type	ØA	B
5SU3020	20	160	160
5SU3025	25	200	160
5SU3028	28	225	160
5SU3030	31	250	160
5SU3036	35	280	160
5SU3040	40	315	160
5SU3045	45	355	160
5SU3054	50	400	160
5SU3056	56	450	160
5SU3063	63	500	160

Dimensioni in mm | Dimensions in mm

1SE | SERRANDA A GRAVITÀ | GRAVITY SHUTTER

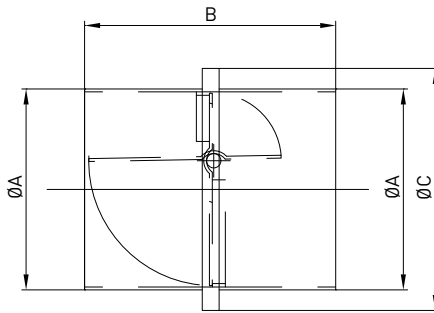

Code	Tipo Type	ØA	B	ØC
1SE2021	20	160	200	240
1SE2026	25	200	200	280
1SE2028	28	225	200	305
1SE2031	31	250	200	330
1SE2035	35	280	200	360
1SE2040	40	315	210	435
1SE2045	45	355	210	475
1SE2049	50	400	210	520
(1)	56	450	210	570
(1)	63	500	210	620

(1) Codice a richiesta. Dimensioni in mm
(1) Item code upon request. Dimensions in mm

1SE | SERRANDA MANUALE | MANUAL SETTING SHUTTER

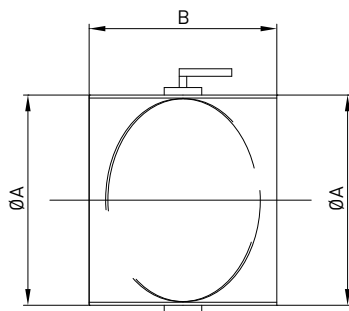

Code	Tipo Type	ØA	B
1SE2022	20	160	120
1SE2027	25	200	120
1SE2030	28	225	120
1SE2032	31	250	120
1SE2036	35	280	140
1SE2041	40	315	140
1SE2046	45	355	140
1SE2050	50	400	140
(1)	56	450	440
(1)	63	500	480

Dimensioni in mm | Dimensions in mm

5RE | RETE DI PROTEZIONE | PROTECTION GUARD

.In acciaio inox
.In stainless steel

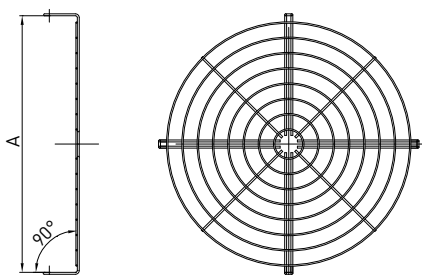

Code	Tipo Type	ØA
5RE2002	20	160
5RE2552	25	200
5RE2802	28	225
5RE2029	31	250
5RE2502	35	280
5RE4004	40	315
5RE4504	45	355
5RE5008	50	400
5RE5600	56	450
5RE6300	63	500

Dimensioni in mm | Dimensions in mm