



S-CUBE P KAT

Cassoni centrifughi pale rovesce per aria ad alta temperatura per cucine industriali (180°C)

Backward curve centrifugal box fans for high temperature air of industrial kitchens (180°C)



sez.

1.11



S-CUBE P KAT aspiratori cassonati | box fans

DESCRIZIONE

I cassoni a pale rovesce insonorizzati S-CUBE P KAT sono progettati per l'aspirazione su cappe da cucina impiegate nel campo della ristorazione e in impianti industriali. La loro caratteristica peculiare consiste nell'aver il motore separato dal flusso d'aria per mezzo di un setto in lamiera zincata, preservando così il motore dalle tipiche sostanze di natura grassa e residui di combustione prodotti dai fornelli delle cucine e riducendo al minimo necessario le operazioni di pulizia e di manutenzione. I pannelli a doppio strato isolati acusticamente riducono il livello di rumore per un migliore comfort anche in caso di installazioni interne. Sono adatti a convogliare aria con temperatura compresa da -20°C a +180°C.

COSTRUZIONE

- Telaio realizzato con profili di alluminio e pannelli smontabili a doppio strato imbottiti con materiale fonoassorbente (sp. 25 mm).
- Esecuzione 5 (accoppiamento diretto con girante a sbalzo su motore flangiato B5).
- Isolamento acustico interno ai pannelli in materiale autoestinguente.
- Girante a pale rovesce in acciaio zincato bilanciata dinamicamente secondo la UNI ISO 21940-11:2017.
- Piedi di fissaggio con fori predisposti per il sollevamento e una facile installazione.

MOTORE

Motori asincroni trifase o monofase a norme internazionali IEC 60034, IEC 60072, EMC 2014/30/UE, LVD 2014/35/UE, marcato CE, IP55, classe F. Tutti idonei ad un servizio S1 (funzionamento continuo a carico costante).

ACCESSORI

- Tettuccio parapigioggia
- Supporti antivibranti
- Piedi di supporto a pavimento
- Raccordo premente e aspirante Quadro-Tondo
- Giunto antivibrante
- Interruttore di servizio IP67
- Vaschetta raccogli grasso
- Pannello inferiore con scarico.

DESCRIPTION

S-CUBE P KAT backward curved impellers box fans are designed for ducted or direct exhaust on kitchen hoods used in the field of catering and industrial plants. The special feature of this box consists in having the motor separated from the air flow by means of a galvanised sheet metal panel, thus preserving the motor from typical oily substances and combustion residues produced by cookers and reducing cleaning and maintenance operations to a minimum. The double skin acoustically insulated panels reduce the noise level for a better comfort also in case of indoor installations. Suitable to convey air in a range of temperature from -20°C up to +180°C.

CONSTRUCTION

- Aluminium frame with double skin sound absorbing insulated panels removable from the impeller side (thick 25 mm).
- Motor external to the stream, B5 execution directly coupled to the impeller.
- Sound absorbing and self-extinguishing material between the steel sheet layers of the panels.
- Galvanized steel sheet backward curved impeller dynamically balanced according to la UNI ISO 21940-11:2017.
- Punched mounting feet for an easy handling and fixing.

MOTOR

Asynchronous squirrel cage three-phase or single-phase motors according to international standards IEC 60034, IEC 60072, EMC 2014/30/UE, LVD 2014/35/UE, CE marked, IP 55, Class F. Suitable to S1 service (continuous running with constant load).

ACCESSORIES

- Water-proof protection cover
- Anti-vibration supports
- Floor support feet
- Square to round outlet and inlet adaptor
- Flexible connector
- Service switch IP67
- Grease collector tray
- Lower panel with drain.

VERSIONI | VERSIONS



S-CUBE P KAT EC

Versioni con motore elettronico ad alta efficienza
Versions with high efficiency electronically controlled motors

PRESTAZIONI | PERFORMANCE

S-CUBE P KAT

Le prestazioni aerauliche sono rilevate in conformità alla norma EN ISO 5801/AMCA 210 con densità dell'aria standard avente peso specifico 1,2 Kg/m³. Alimentazione 230V/1Ph/50Hz o 400V/3Ph/50Hz. Air performances measured according to EN ISO 5801 / AMCA 210 standard with air density with 1.2 Kg/m³ specific weight. Power supply 230V/1Ph/50Hz or 400V/3Ph/50Hz.

Lp Livello di pressione sonora rilevato in condizioni di campo libero, propagazione emisferica, categoria di misura C a norma EN ISO 13349, nel punto di massimo rendimento, alla distanza di 3 metri dal lato aspirazione e si presenta solo per fini comparativi. Sound pressure level measured in free field conditions, propagation hemispherical, measurement category C in accordance with EN ISO 13349, at the point of maximum efficiency, at a distance of 3 meters, inlet side (for comparative purposes only).

Lw Livello di potenza sonora ottenuto secondo norma ISO 3746. Tolleranza +/- 3 dB(A). Sound power level obtained in accordance with EN ISO 3746. Tolerance +/- 3 dB(A).

S-CUBE P KAT 31

Code	Tipo Type	Modello Model	U	P	Pm (kW)	In (A)	IP/CL	IE3	Mot. (Gr)
1SK3151	S-CUBE P KAT	314	M	4	0,18	1,10	55/F	-	63
1SK3150			T	4	0,18	0,65	55/F	-	63

LIVELLI SONORI | SOUND LEVELS dB(A)

Hz		63	125	250	500	1000	2000	4000	8000	TOT
314	Lw	40	54	60	65	65	62	57	46	70
	Lp	20	33	40	44	44	41	36	25	49

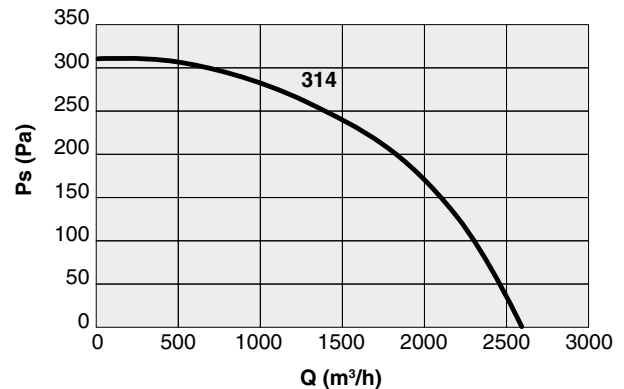

S-CUBE P KAT 35

Code	Tipo Type	Modello Model	U	P	Pm (kW)	In (A)	IP/CL	IE3	Mot. (Gr)
1SK3551	S-CUBE P KAT	354	M	4	0,25	1,55	55/F	-	71
1SK3550			T	4	0,25	0,90	55/F	-	71
1SK3553			T	6	0,12	0,55	55/F	-	63

LIVELLI SONORI | SOUND LEVELS dB(A)

Hz		63	125	250	500	1000	2000	4000	8000	TOT
354	Lw	43	57	64	66	67	64	61	49	72
	Lp	22	36	43	46	46	43	40	29	51
356	Lw	25	39	46	49	50	47	43	32	55
	Lp	13	27	34	37	38	35	31	20	43

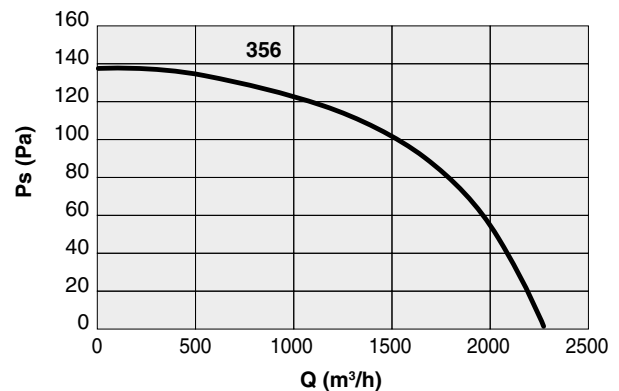
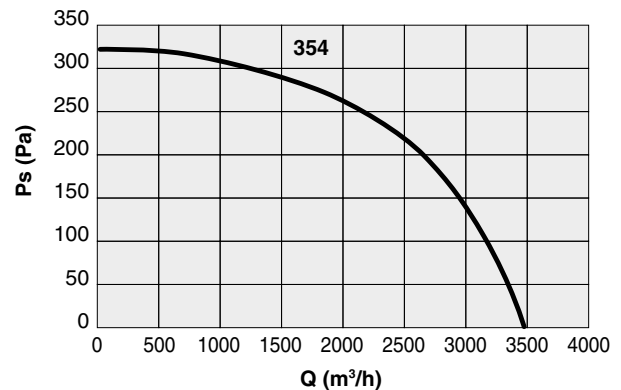

SEZ.
1.11

S-CUBE P KAT aspiratori casonati | box fans

S-CUBE P KAT 40

Code	Tipo Type	Modello Model	U	P	Pm (kW)	In (A)	IP/CL	IE3	Mot. (Gr)
1SK4051	S-CUBE P KAT	404	M	4	0,55	2,95	55/F	-	80
1SK4050			T	4	0,55	1,70	55/F	-	80
1SK4053		406	T	6	0,18	0,70	55/F	-	71

LIVELLI SONORI | SOUND LEVELS dB(A)

Hz		63	125	250	500	1000	2000	4000	8000	TOT
404	Lw	46	60	67	70	70	67	63	52	75
	Lp	25	39	47	50	50	47	42	32	55
406	Lw	29	42	50	53	53	50	45	35	58
	Lp	17	30	38	41	41	38	33	23	46

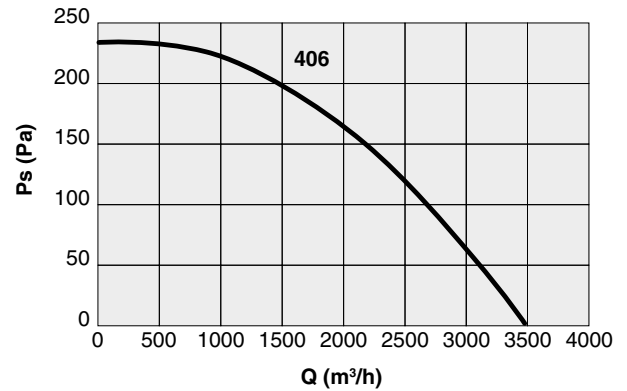
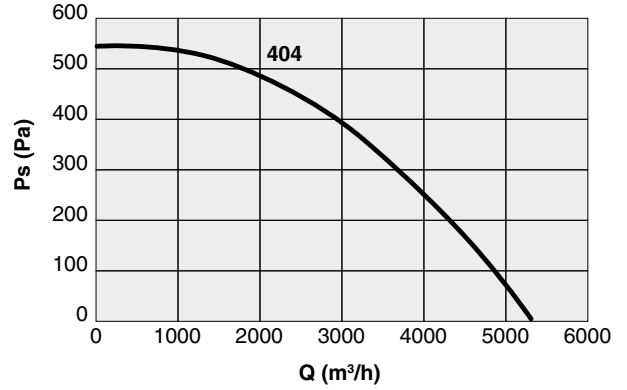

S-CUBE P KAT 45

Code	Tipo Type	Modello Model	U	P	Pm (kW)	In (A)	IP/CL	IE3	Mot. (Gr)
1SK4551	S-CUBE P KAT	454	M	4	0,75	3,60	55/F	✓	80
1SK4550			T	4	0,75	2,10	55/F	✓	80
1SK4553		456	T	6	0,37	1,20	55/F	-	80

LIVELLI SONORI | SOUND LEVELS dB(A)

Hz		63	125	250	500	1000	2000	4000	8000	TOT
454	Lw	46	61	69	72	73	71	66	55	78
	Lp	25	41	48	52	53	50	45	35	57
456	Lw	28	44	52	55	56	54	48	38	61
	Lp	16	32	40	43	44	42	36	26	49

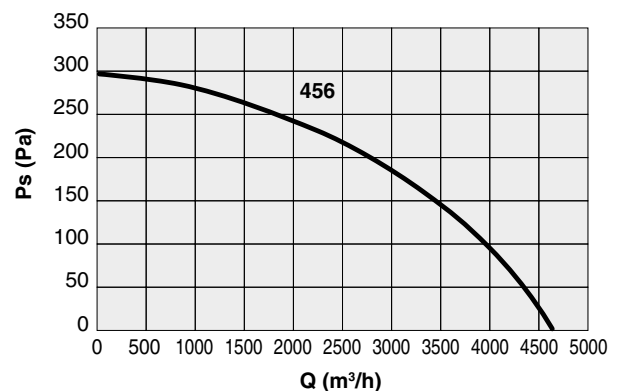
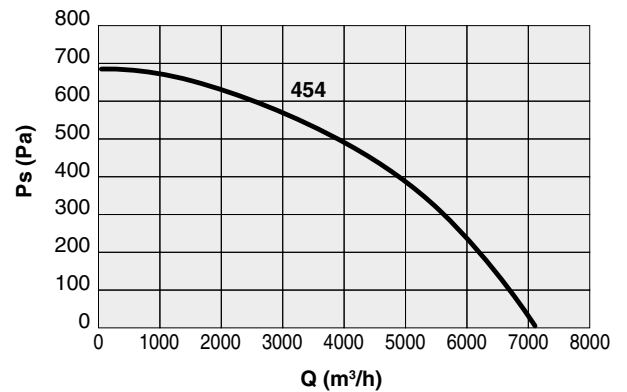

S-CUBE P KAT 50

Code	Tipo Type	Modello Model	U	P	Pm (kW)	In (A)	IP/CL	IE3	Mot. (Gr)
1SK5050	S-CUBE P KAT	504	T	4	1,50	3,40	55/F	✓	90
1SK5051		506	T	6	0,55	1,40	55/F	-	80

LIVELLI SONORI | SOUND LEVELS dB(A)

Hz		63	125	250	500	1000	2000	4000	8000	TOT
504	Lw	42	52	62	65	66	63	56	47	70
	Lp	30	40	50	53	54	51	44	35	58
506	Lw	42	52	61	64	65	63	56	46	70
	Lp	22	32	41	44	45	43	36	26	50

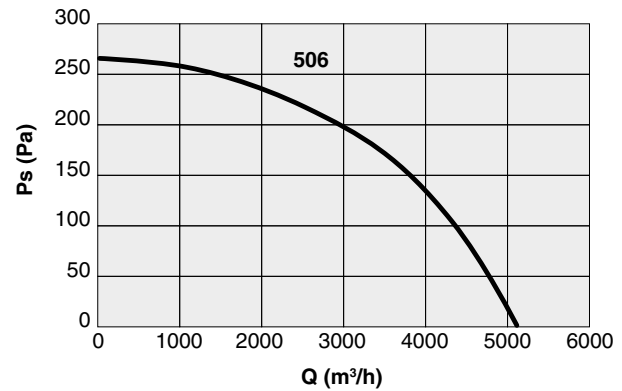
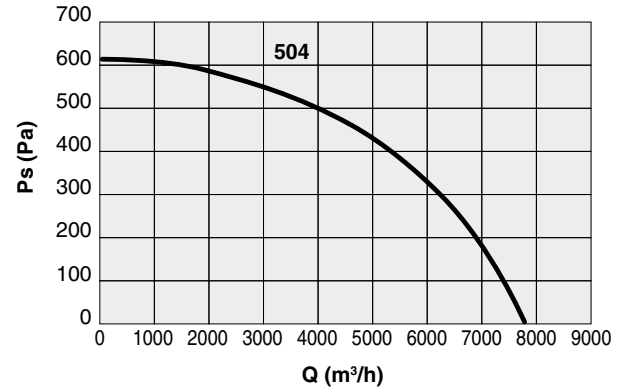

S-CUBE P KAT 56

Code	Tipo Type	Modello Model	U	P	Pm (kW)	In (A)	IP/CL	IE3	Mot. (Gr)
1SK5651	S-CUBE P KAT	564	T	4	3,00	6,30	55/F	✓	100
1SK5650		566	T	6	0,55	1,40	55/F	-	80

LIVELLI SONORI | SOUND LEVELS dB(A)

Hz		63	125	250	500	1000	2000	4000	8000	TOT
564	Lw	51	62	68	70	72	70	63	54	77
	Lp	39	50	56	58	60	58	51	42	65
566	Lw	51	62	68	70	71	69	63	54	76
	Lp	30	41	48	50	51	49	43	33	56

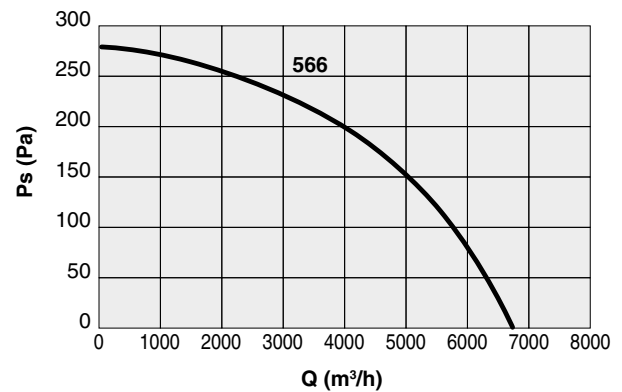
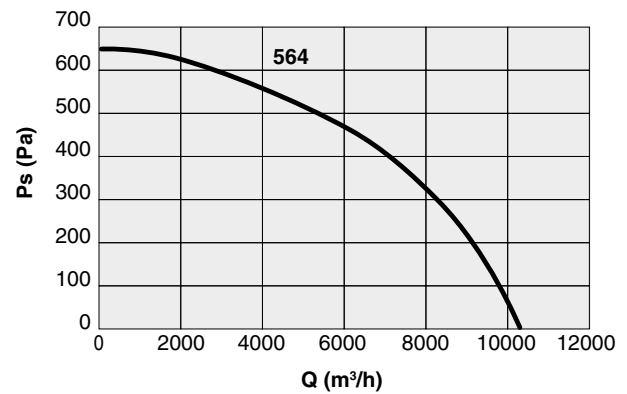

S-CUBE P KAT 63

Code	Tipo Type	Modello Model	U	P	Pm (kW)	In (A)	IP/CL	IE3	Mot. (Gr)
1SK6351	S-CUBE P KAT	634	T	4	5,50	10,40	55/F	✓	132
1SK6350		636	T	6	1,10	2,80	55/F	✓	90

LIVELLI SONORI | SOUND LEVELS dB(A)

Hz		63	125	250	500	1000	2000	4000	8000	TOT
634	Lw	52	65	71	75	76	74	69	60	81
	Lp	40	53	59	63	64	62	57	48	69
636	Lw	52	65	71	74	75	73	68	60	80
	Lp	32	44	51	54	55	53	48	40	60

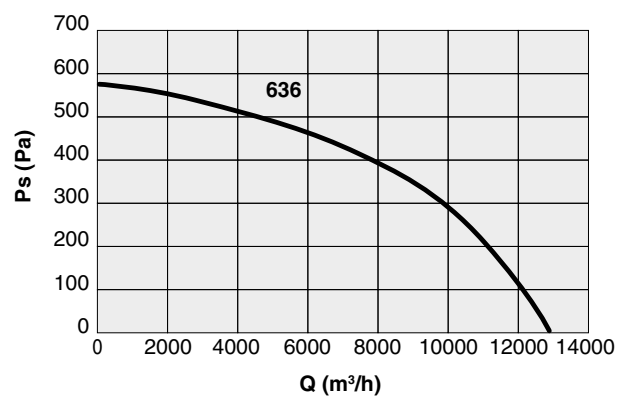
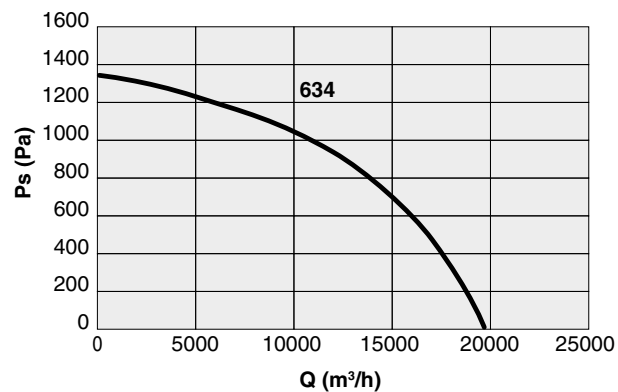

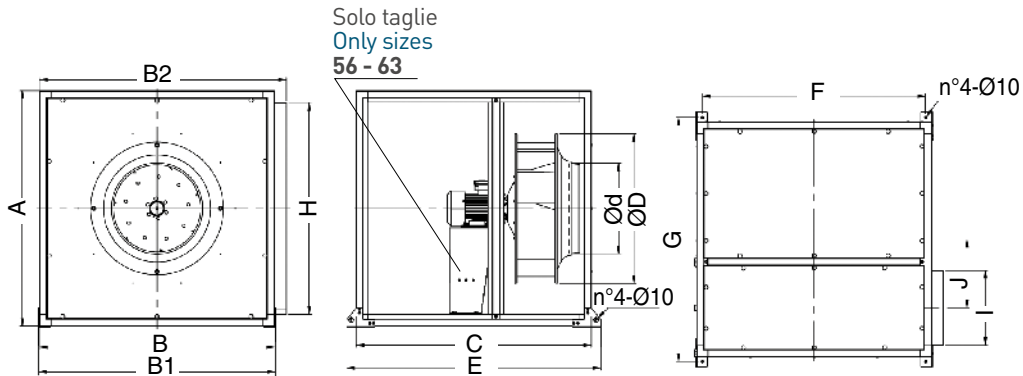

SOLO PER VERSIONE 63 | ONLY FOR VERSION 63

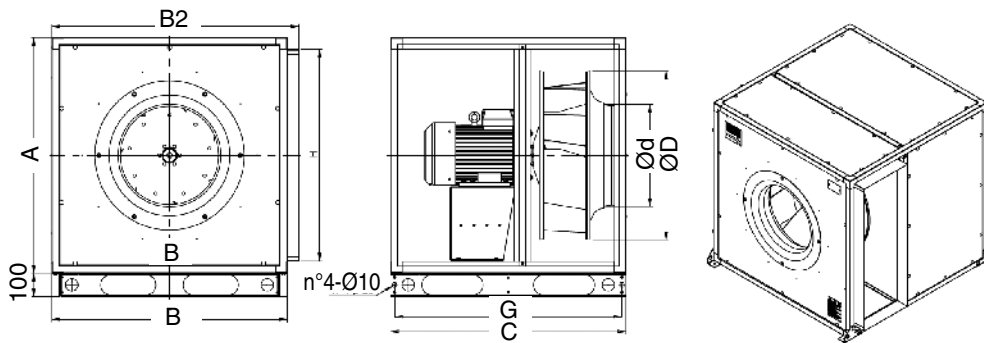

S-CUBE P KAT

TIPO TYPE	A	B	B1	B2	C	Ød	ØD	E	F	G	H	I	J	Kg
S-CUBE P KAT 31	650	650	656	689	650	215	360	730	598	686	549	158	195	57
S-CUBE P KAT 35	650	650	656	689	650	243	404	730	598	686	549	173	188	59
S-CUBE P KAT 40	750	750	756	799	750	275	455	830	698	786	649	208	220	80
S-CUBE P KAT 45	750	750	756	799	750	309	505	830	698	786	649	233	208	85
S-CUBE P KAT 50	750	750	756	799	750	343	566	830	698	786	649	288	180	102
S-CUBE P KAT 56 - 6P	1000	1000	1006	1050	1000	384	636	1080	948	1036	899	318	290	152
S-CUBE P KAT 56 - 4P	1000	1000	1006	1050	1000	384	636	1080	948	1036	899	318	290	175
S-CUBE P KAT 63 - 6P	1000	1000	1006	1050	1000	433	716	1000	-	965	899	353	273	177
S-CUBE P KAT 63 - 4P	1000	1000	1006	1050	1000	433	716	1000	-	965	899	353	273	234

Pesi indicativi | Indicative weights

INSTALLAZIONE

Versatilità di posizionamento nella fase di installazione del prodotto, il cassone può essere infatti montato sia in orizzontale che in verticale indifferentemente. Possono inoltre essere installati all'aperto utilizzando l'apposito tettuccio parapiooggia disponibile come accessorio.

INSTALLATION

S-CUBE P KAT installation is easy thanks to the highly flexible positioning of the product. Indeed, this box fan can be indifferently installed in both vertical and horizontal position and is suitable for outdoor installations (we suggest the use of a water-proof protection cover, available as accessory).

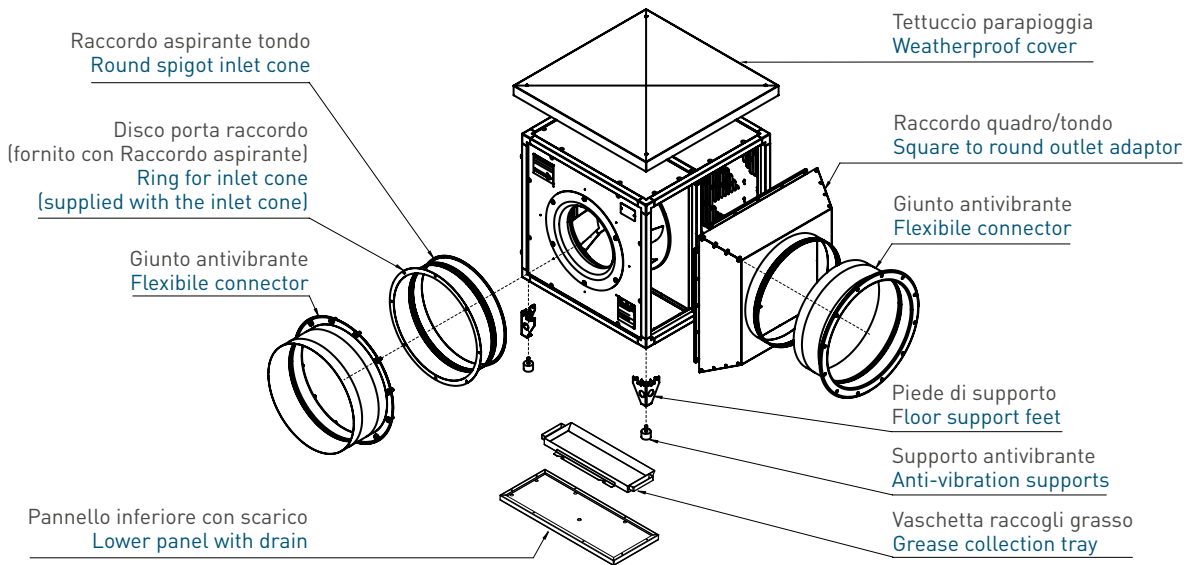

TETTUCCIO PARAPIOGGIA | WEATHERPROOF COVER

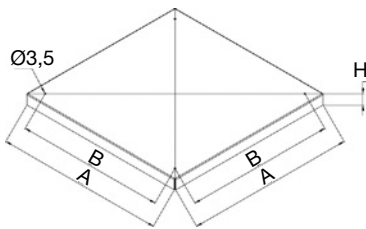

Code	Tipo Type	A	B	H	Kg
5TE0081	31 / 35	700	618	35	3,70
5TE0082	40 / 45 / 50	800	720	50	5,00
5TE0083	56 / 63	1050	970	50	8,20

Dimensioni in mm | Dimensions in mm

RACCORDO QUADRO/TONDO | SQUARE TO ROUND OUTLET ADAPTOR

Da abbinare ai piedi 1ST0027.

To be installed with support feet 1ST0027.

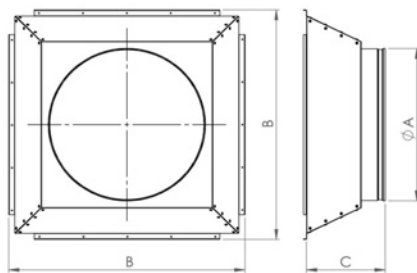

Code	Tipo Type	ØA	B	C	Kg
5RA2025	31	355	655	161	4
5RA2026	35	400	655	178	4,4
5RA2014	40	450	753	252	6,4
5RA2015	45	500	753	249	6,2
5RA2018	50	560	753	246	6,3
5RA2019	56	630	1005	246	9,1
5RA2020	63	710	1005	250	9,4

Dimensioni in mm | Dimensions in mm

GIUNTO ANTIVIBRANTE | FLEXIBLE CONNECTOR

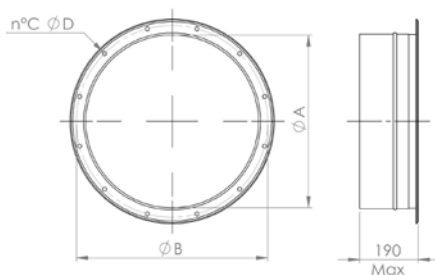

Code	Tipo Type	ØA	ØB	C	ØD	Kg
1SU5107	31	305	355	8	10	1,7
1SU5100	35	355	395	8	10	1,9
1SU5101	40	405	450	8	12	2,2
1SU5102	45	455	500	8	12	2,4
1SU5103	50	505	560	12	12	2,9
1SU5104	56	565	620	12	12	3,0
1SU5105	63	635	690	12	12	3,4

Dimensioni in mm | Dimensions in mm



RACCORDO ASPIRANTE TONDO | ROUND SPIGOT INLET CONE

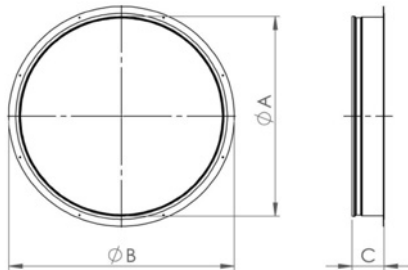

Code	Tipo Type	ØA	ØB	C	Kg
1TR0016	31	355	400	56	0,7
1TR0017	35	400	450	56	0,8
1TR0018	40	450	500	56	0,9
1TR0019	45	500	550	78,5	1,2
1TR0020	50	560	610	78,5	1,3
1TR0021	56	630	680	78,5	1,5
1TR0022	63	710	760	78,5	1,8

Dimensioni in mm | Dimensions in mm

1ST0027 | PIEDE DI SUPPORTO A PAVIMENTO | FLOOR SUPPORT FEET

N°4 piedi da utilizzare in abbinamento al pannello inferiore con scarico condensa e grasso (ad esclusione dei modelli 630).

N° 4 feet to be used coupled with the condensate and grease drain inferior panel (except models 630).

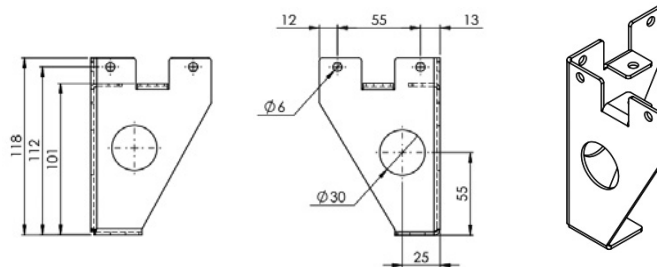

SUPPORTI ANTIVIBRANTI | ANTI-VIBRATION SUPPORTS

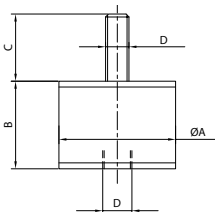

Code	Tipo Type	ØA	B	C	D	Carico a compressione per 1 supporto (Kg) Compression load for 1 support (Kg)
5SU1057	31 / 35 / 40	30	20	23	M8	21 ÷ 45
5SU1054	45 / 50 / 56 / 63	40	30	28	M10	46 ÷ 65

Dimensioni in mm | Dimensions in mm

VASCHETTA RACCOGLI GRASSO | GREASE COLLECTION TRAY

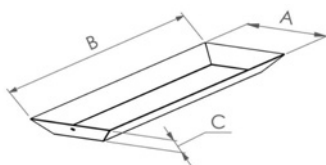

Code	Tipo Type	A	B	C	Kg
1KT0404	31 / 35	177	567	29	1,1
1KT0405	40 / 45 / 50	200	650	36	1,3
1KT0406	56 / 63	300	900	40	1,7

Dimensioni in mm | Dimensions in mm

PANNELLO INFERIORE CON SCARICO | LOWER PANEL WITH DRAIN

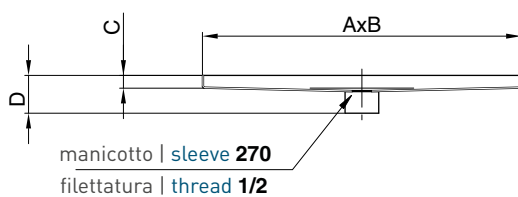

Code	Tipo Type	A	B	C	D	Kg
5PN1585	31	587	197	20	40	1,2
5PN1586	35	587	212	20	40	1,4
5PN1587	40	687	247	20	40	1,6
5PN1588	45	687	272	20	40	1,7
5PN1589	50	687	327	20	40	2
5PN1590	56	937	357	20	40	2,8
5PN1591	63	937	392	20	40	3

Dimensioni in mm | Dimensions in mm